

# GT PRESSURA

---



---

## About

GT Pressura is inspired by metal type printing history as well as engineered letters stamped onto shipping boxes. It uses the visual gesture of ink spreading under pressure as a stylistic device, offering an alternative to more spindly typefaces of the digital age.

## Designed by

Dominik Huber (Moiré)  
Marc Kappeler (Moiré)

## Details

Released 2012 / 2017  
Available in 12 Styles  
For Desktop, Web, App Licensing

## Grilli Type

---

Pressura	Standard	Italic	Pro Standard	Pro Italic	Pressura	Mono	Mono Italic	Pro Mono	Pro Mono Italic
Light	A a	<i>A a</i>	A a	<i>A a</i>	Light	A a	<i>A a</i>	Я Я	<i>Я Я</i>
Regular	B b	<i>B b</i>	Б б	<i>Б б</i>	Regular	B b	<i>B b</i>	Б б	<i>Б б</i>
Bold	<b>C c</b>	<b><i>C c</i></b>	<b>В в</b>	<b><i>В в</i></b>	Bold	<b>C c</b>	<b><i>C c</i></b>	<b>В в</b>	<b><i>В в</i></b>

---

The inspiration for this typefaces stems from Soviet movie subtitles and typography stamped on shipping boxes. GT Pressura uses the visual effect of ink spreading under pressure as a stylistic device.

  
KEEP DRY

  
UP

  
FRAGILE

  
NUMBER

---

**ASTROARCADE, INC.**  
325 N. STATE ST.  
*GARNER, IOWA 50438*

---

AMAZIN MAZE	DESC: XBOX 360
TIC-TAC-TOE	Rock Band
5001-8014	SKU#: 19160
	ORIG: China
	G.W.: 8.65 lbs
RED BARON	CUBE: 0.96 cuft
PANZER ATAK	PACK: 2PCS
2003-4002	CTNU: 863

---

RADIOLOGICAL V-487  
WOOL COLLER STYLE NO:  
XC2013QTY 60 PCS

---

**HEAVY**  
**HANDLE WITH CARE**

---

This package is qualified to ship 11 through 20 drives per the following instructions: To leave one empty cell, remove drive X 1; two empty cells, remove drive X 1 and X 2 etc.If you require additional instructions or packing material, visit our support center at [www.seagate.com](http://www.seagate.com)

ГОСКИНОТ



КИНО ГЛАЗ

6

Серий  
работа вертова  
оператор кауфман

---

ГОРОДОСТЬ СОВЕТСКОЙ КИНЕМАТОГРАФИИ



Производство  
фабрики госкино
пзйзенштейна  
оператор тиссэ

  
KEEP DRY

  
UP

  
FRAGILE

  
NUMBER

---

**ASTROARCADE, INC.**  
325 N. STATE ST.  
*GARNER, IOWA 50438*

---

AMAZIN MAZE	DESC: XBOX 360
TIC-TAC-TOE	Rock Band
5001-8014	SKU#: 19160
	ORIG: China
	G.W.: 8.65 lbs
RED BARON	CUBE: 0.96 cuft
PANZER ATAK	PACK: 2PCS
2003-4002	CTNU: 863

---

RADIOLOGICAL V-487  
WOOL COLLER STYLE NO:  
XC2013QTY 60 PCS

---

**HEAVY**  
**HANDLE WITH CARE**

---

This package is qualified to ship 11 through 20 drives per the following instructions: To leave one empty cell, remove drive X 1; two empty cells, remove drive X 1 and X 2 etc.If you require additional instructions or packing material, visit our support center at [www.seagate.com](http://www.seagate.com)

Concept

Clear stamp

Printed stamp

Vectorised shape

Process

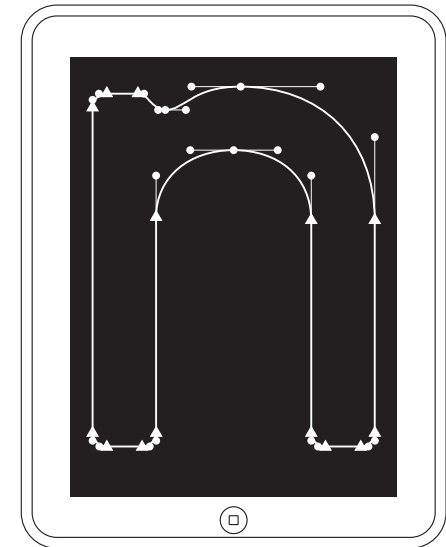
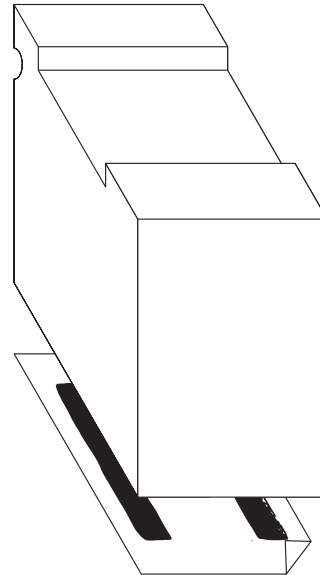
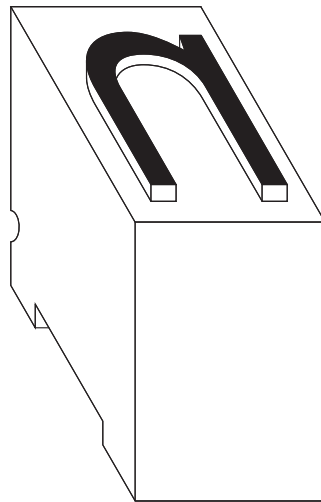

Result



## Grilli Type

---

GT Pressura	OpenType Features	
Tabular Lining Numbers	4.2.2017 1.1.2017	4.2.2017 1.1.2017
Slashed zero	0	0
Automatic fractions	3/4×13/77	¾×¹³/₇₇
Superscript Subscript Superior	Note¹ H₂O 13 (2x+8y)	Note¹ H₂O 13 (²ˣ+⁸ʸ)
Capital spacing	CAPITAL	CAPITAL
Case sensitive forms	¿QUE? (SECTRA) 23+4=27	¿QUE? (SECTRA) 23+4=27

GT Pressura	Stylistic Alternates	
Language Feature Romanian Moldavian	și societății și societății ȘI SOCIETĂȚII	și societății și societății ȘI SOCIETĂȚII
Language Feature Bulgarian	България Любов Надежда Душа	България Любов Надежда Душа
Language Feature Serbian Macedonian	Србија	Србија
Language Feature Ukrainian	Роніі іі	Роніі іі

Д→Д Л→Л в→в г→г д→г

ж→ж з→з и→и й→й

к→к л→л т→т п→п

ц→ц ш→ш щ→щ ю→ю

Language Feature OFF

Language Feature ON

---

Bulgarian

Любов

---

Любов

---

Bulgarian

Душа

---

Душа

---

Bulgarian

Флаг

---

Флаг

---

Serbian and Macedonian

Србија

---

Србија

---

## Uppercase Latin

A	B	C	D	E	F	G	H	I	J	K	L	M	N	O
A	B	C	D	E	F	G	H	I	J	K	L	M	N	O
P	Q	R	S	T	U	V	W	X	Y	Z	Á	Ă	Â	Ä
P	Q	R	S	T	U	V	W	X	Y	Z	Aacute	Abreve	Acircumflex	Adieresis
Æ	Ā	À	Ā	Ą	Å	Ã	Ć	Č	Ç	Ĉ	Ċ	Ǿ	Đ	É
AE	AEacute	Agrave	Amacron	Aogonek	Aring	Atilde	Cacute	Ccaron	Ccedilla	Ccircumflex	Cdotaccent	Dcaron	Dcroat	Eacute
Ě	Ě	Ê	Ë	È	È	Ē	Ę	Ğ	Ĝ	Ġ	Ġ	Ĥ	Ĥ	Í
Ebreve	Ecaron	Ecircumflex	Edieresis	Edotaccent	Egrave	Emacron	Eogonek	Gbreve	Gcircumflex	Gcommaac	Gdotaccent	Hbar	Hcircumflex	Iacute
Ī	Î	Ï	İ	Ì	Ĳ	Ī	Ĵ	Ĩ	Ĵ	Ɔ	Í	Ĺ	Ł	Ł
Ibreve	Icircumflex	Idieresis	Idotaccent	Igrave	IJ	Imacron	Iogonek	Itilde	Jcircumflex	Kcommaac	Lacute	Lcaron	Lcommaac	Ldot
Ł	Ń	Ń	Ń	Ń	Ń	Ó	Ŏ	Ô	Ö	Œ	Ò	Ó	Ō	Ø
Lslash	Nacute	Ncaron	Ncommaac	Ntilde	Eng	Oacute	Obreve	Ocircumflex	Odieresis	OE	Ograve	Ohungarum	Omacron	Oslash
Ø	Ŏ	Ŕ	Ř	Ŕ	Ś	Š	Ş	Ŝ	Ş	Ʀ	Ť	Ť	Ť	Ƨ
Oslashacute	Otilde	Racute	Rcaron	Rcommaac	Sacute	Scaron	Scedilla	Scircumflex	Scommaac	Tbar	Tcaron	Tcedilla	Tcommaac	Thorn
Ú	Ŭ	Û	Ü	Ù	Ú	Ū	Ű	Ū	Ū	Ŵ	Ŷ	Ŵ	Ŵ	Ý
Uacute	Ubreve	Ucircumflex	Udieresis	Ugrave	Uhungarum	Umacron	Uogonek	Uring	Utilde	Wacute	Wcircumfle	Wdieresis	Wgrave	Yacute
Ŷ	ÿ	ÿ	Ž	Ž	Ž	ß	Đ							
Ycircumflex	Ydieresis	Ygrave	Zacute	Zcaron	Zdotaccent	Germandbls	Eth							



## Lowercase Latin

a	b	c	d	e	f	g	h	i	j	k	l	m	n	o
a	b	c	d	e	f	g	h	i	j	k	l	m	n	o
p	q	r	s	t	u	v	w	x	y	z	á	ă	â	ä
p	q	r	s	t	u	v	w	x	y	z	aacute	abreve	acircumflex	adieresis
æ	æ	à	ā	ą	å	ã	ć	č	ç	ĉ	ċ	d'	đ	é
ae	aeacute	agrave	amacron	aogonek	aring	atilde	cacute	ccaron	ccedilla	ccircumflex	cdotaccent	dcaron	dcroat	eacute
ě	ě	ê	ë	è	è	ē	ę	ğ	ĝ	ġ	ġ	ħ	ĥ	í
ebreve	ecaron	ecircumflex	edieresis	edotaccent	egrave	emacron	eogonek	gbreve	gcircumflex	gcommaac	gdotaccent	hbar	hcircumflex	iacute
ï	î	ï	ı	ı	ì	ij	ī	ı	ĩ	ĵ	ĵ	ķ	ķ	í
ibreve	icircumflex	idieresis	idotaccent	idotless	igrave	ij	imacron	iogonek	itilde	jcircumflex	jdotless	kcommaac	kgreenland	lacute
l'	l,	ḷ	ł	ń	ň	ň	ŋ	ñ	ŋ	ó	ö	ô	ö	œ
lcaron	lcommaac	ldot	lslash	nacute	napostrophe	ncaron	ncommaac	ntilde	eng	oacute	obreve	ocircumflex	odieresis	oe
ò	ó	ō	ø	ø	õ	í	ř	ř	ś	š	ş	ș	ş	ț
ograve	ohungarum	omacron	oslash	oslashacute	otilde	racute	rcaron	rcommaac	sacute	scaron	scedilla	scircumflex	scommaac	tbar
ţ	ţ	ţ	þ	ú	ů	û	ü	ù	ű	ū	ų	ů	ũ	w
tcaron	tcedilla	tcommaac	thorn	uacute	ubreve	ucircumflex	udieresis	ugrave	uhungarum	umacron	uogonek	uring	utilde	wacute
ŵ	w̄	Ẁ	ý	ÿ	ÿ	ÿ	ź	ž	ż	ß	đ			
wcircumflex	wdieresis	wgrave	yacute	ycircumflex	ydieresis	ygrave	zacute	zcaron	zdotaccent	germandbls	eth			

## Uppercase cyrillic

А	Б	В	Г	Ґ	Г	Д	Е	È	Ё	Ж	З	И	Й	Ў
A-cy	Be-cy	Ve-cy	Ge-cy	Gje-cy	Gheupturn-cy	De-cy	Ie-cy	legrave-cy	Io-cy	Zhe-cy	Ze-cy	Ii-cy	Ishort-cy	Ishorttail-cy
Й	К	Ќ	Л	М	Н	О	П	Р	С	Т	У	Ў́	Ф	Х
Igrave-cy	Ka-cy	Kje-cy	El-cy	Em-cy	En-cy	O-cy	Pe-cy	Er-cy	Es-cy	Te-cy	U-cy	Ushort-cy	Ef-cy	Ha-cy
Ч	Ц	Ш	Щ	Ц	Ь	Ъ	Ы	Ь	НЬ	Ѕ	Є	Э	І	Ї
Che-cy	Tse-cy	Sha-cy	Shcha-cy	Dzhe-cy	Softsign-cy	Hardsign-cy	Yeru-cy	Lje-cy	Nje-cy	Dze-cy	E-cy	Ereversed-cy	I-cy	Yi-cy
Ј	Ћ	Ю	Я	Ђ	Ђ	Ө	У	Ф	Ђ	Ж	З	К	К	К
Je-cy	Tshe-cy	Iu-cy	Ia-cy	Dje-cy	Yat-cy	Fita-cy	Izhitsa-cy	Ghestroke	Ghemiddleh	Zhedescender	Zedescender	Kadescender	Kaverticallstr	Kastroke
К	Њ	Н	Њ	Ц	Ѓ	Ѓ	Т	У	У	Х	Ц	Ч	Ч	Һ
Kabashkir-cy	Endescender	Enghe-cy	Pemiddlehook	Pedescender	Haabkhasian	Esdescender	Tedescender	Ustrait-cy	Ustraitstroke	Hadescender	Tetse-cy	Chedescender	Cheverticalstr	Shha-cy
Һ	Е	Е	І	Ж	Ѓ	Л	Н	Н	Ч	М	Ѓ	Ѓ	Æ	Ё
Shhadesc	Cheabkhasian	Chedescabkh	Palochka-cy	Zhebreve-cy	Kahook-cy	Eltail-cy	Enhook-cy	Entail-cy	Chekhakassian	Emtail-cy	Abreve-cy	Adieresis-cy	Aie-cy	Iebreve-cy
Ə	Ə	Ж	З	З	Й	Й	Ö	Ө	Ө	Э	Ү	Ү	Ү́	Ү́
Schwa-cy	Schwadieresis	Zhedieresis	Zedieresis	Dzeabkhasian	Imacron-cy	Idieresis-cy	Odieresis-cy	Obarred-cy	Obarreddieres	Edieresis-cy	Umacron-cy	Udieresis-cy	Uhungaruml	Chedieresis-cy
Г	Ы́	Х	Е	Л	W	Ђ	Р							
Gedescender	Yerudieresis	Hahook-cy	Reversedze-cy	Elhook-cy	We-cy	Semisoftsign	Ertick-cy							

## Lowercase cyrillic

а	б	в	г	ѓ	ґ	д	е	è	ë	ж	з	и	й	ѣ
a-cy	be-cy	ve-cy	ge-cy	gje-cy	gheupturn-cy	de-cy	ie-cy	iegrave-cy	io-cy	zhe-cy	ze-cy	ii-cy	iishort-cy	iishorttail-cy
й	к	ќ	л	м	н	о	п	р	с	т	у	ў	ф	х
iigrave-cy	ka-cy	kje-cy	el-cy	em-cy	en-cy	o-cy	pe-cy	er-cy	es-cy	te-cy	u-cy	ushort-cy	ef-cy	ha-cy
ч	ц	ш	щ	џ	ь	њ	ы	лъ	нь	ѕ	є	э	і	ї
che-cy	tse-cy	sha-cy	shcha-cy	dzhe-cy	softsign-cy	hardsign-cy	yeru-cy	lje-cy	nje-cy	dze-cy	e-cy	ereversed-cy	i-cy	yi-cy
ј	ћ	ю	я	ђ	џ	Ѡ	ѡ	Ѣ	ѣ	Ѥ	ѥ	Ѧ	ѧ	Ѩ
je-cy	tshe-cy	iu-cy	ia-cy	dje-cy	yat-cy	fita-cy	izhitsa-cy	ghestroke	ghemiddleh	zhedescender	zedescender	kadescender	kaverticestr	kastroke
Ѧ	ѧ	Ѩ	ѩ	Ѫ	ѫ	Ѭ	ѭ	Ѯ	ѯ	Ѱ	ѱ	Ѳ	ѳ	Ѵ
kabashkir-cy	endescender	enghe-cy	pemiddlehook	pedescender	haabkhasian	esdescender	tedescender	ustrait-cy	ustraitstroke	hadescender	tetse-cy	chedescender	cheverticalstr	shha-cy
ѵ	Ѷ	ѷ	Ѹ	ѹ	Ѻ	ѻ	Ѽ	ѽ	Ѿ	ѿ	Ѡ	ѡ	Ѣ	ѣ
shhadesc	cheabkhasian	chedescabkh	palochka-cy	zhebreve-cy	kahook-cy	eltail-cy	enhook-cy	entail-cy	chekhakassian	emtail-cy	abreve-cy	adieresis-cy	aie-cy	iebreve-cy
Ѥ	ѥ	Ѧ	ѧ	Ѩ	ѩ	Ѫ	ѫ	Ѭ	ѭ	Ѯ	ѯ	Ѱ	ѱ	Ѳ
schwa-cy	schwadieresis	zhedieresis	zedieresis	dzeabkhasian	imacron-cy	idieresis-cy	odieresis-cy	obarred-cy	obarreddieres	edieresis-cy	umacron-cy	udieresis-cy	uhungaruml	chedieresis-cy
Ѵ	ѵ	Ѷ	ѷ	Ѹ	ѹ	Ѻ	ѻ	Ѽ	ѽ	Ѿ	ѿ	Ѡ	ѡ	Ѣ
gedescender	yerudieresis	hahook-cy	reversedze-cy	elhook-cy	we-cy	semisoftsign	ertick-cy							

## Greek

Α	Β	Γ	Δ	Ε	Ζ	Η	Θ	Ι	Κ	Λ	Μ	Ν	Ξ	Ο
Alpha	Beta	Gamma	Delta	Epsilon	Zeta	Eta	Theta	Iota	Kappa	Lambda	Mu	Nu	Xi	Omicron
Π	Ρ	Σ	Τ	Υ	Φ	Χ	Ψ	Ω	Ά	Έ	Ή	Ί	Ό	Υ
Pi	Rho	Sigma	Tau	Upsilon	Phi	Chi	Psi	Omega	Alphatonos	Epsilontonos	Etatonos	Iotatonos	Omicrontonos	Upsilontonos
Ό	ϊ	ϋ	α	β	γ	δ	ε	ζ	η	θ	ι	κ	λ	μ
Omegatonos	Iotadieresis	Upsilondieresis	alpha	beta	gamma	delta	epsilon	zeta	eta	theta	iota	kappa	lambda	mu
ν	ξ	ο	π	ρ	ς	σ	τ	υ	φ	χ	ψ	ω	ί	ϊ
nu	xi	omicron	pi	rho	sigmafinal	sigma	tau	upsilon	phi	chi	psi	omega	iotatonos	iotadieresis
ϊ	ύ	ϋ	ϋ	ό	ώ	ά	έ	ή						
tonos	upsilontonos	upsilondieresis	upsilondieresi	omicrontonos	omegatonos	alphatonos	epsilontonos	etatonos						

## Vietnamese

Á	Ă	Â	À	Ã	Ắ	Ặ	Ằ	Ẵ	Ẳ	Ẵ	Ậ	Ằ	Ẵ	Ẵ
Aacute	Abreve	Acircumflex	Agrave	Atilde	Abreveacute	Abrevedotbel	Abrevegrave	Abrevehookab	Abrevetilde	Acircumflexa	Acircumflexd	Acircumflex	Acircumflex	Acircumflextil
Ạ	Ằ	Đ	É	Ê	È	Ế	Ệ	Ề	Ễ	Ễ	Ệ	Ẻ	Ễ	Í
Adotbelow	Ahookabove	Dcroat	Eacute	Ecircumflex	Egrave	Ecircumflex	Ecircumflexdo	Ecircumflexg	Ecircumflexho	Ecircumflex	Edotbelow	Ehookabove	Etilde	Iacute
Ì	Ĩ	Ị	Ỉ	Ó	Ô	Ò	Õ	Ỡ	Ộ	Ồ	Ổ	Ỡ	Ọ	Ỏ
Igrave	Itilde	Idotbelow	Ihookabove	Oacute	Ocircumflex	Ograve	Otilde	Ocircumflexac	Ocircumflexd	Ocircumflex	Ocircumflexho	Ocircumflexi	Odotbelow	Ohooka
Ơ	Ớ	Ợ	Ờ	Ở	Ỡ	Ú	Ù	Û	Ụ	Ủ	Ư	Ứ	Ự	Ừ
Ohorn	Ohornacute	Ohorndotbelow	Ohorngrave	Ohornhookabove	Ohorntilde	Uacute	Ugrave	Utilde	Udotbelow	Uhookabove	Uhorn	Uhornacute	Ohorndotbelow	Ohorngrave
Ủ	Ữ	Ỡ	Ỡ	Ỡ	Ỡ	á	ă	â	à	ã	ắ	ặ	ặ	ặ
Uhornhookab	Uhorntilde	Yacute	Ygrave	Ydotbelow	Yhookabove	Ytilde	aacute	abreve	acircumflex	agrave	atilde	abreveacute	abrevedotbe	abrevegrave
ằ	ẳ	ẵ	ậ	ằ	ẳ	ẵ	ạ	ằ	đ	é	ê	è	ế	ệ
abrevehooka	abrevetilde	acircumflex	acircumflexdo	acircumflex	acircumflex	acircumflex	adotbelow	ahookabove	dcroat	eacute	ecircumflex	egrave	ecircumflexa	ecircumflexdo
ề	ễ	ễ	ệ	ẻ	ễ	í	ì	ĩ	ị	ỉ	ó	ô	ò	õ
ecircumflex	ecircumflexho	ecircumflexi	edotbelow	ehookabove	etilde	iacute	igrave	itilde	idotbelow	ihookabove	oacute	ocircumflex	ograve	otilde
ỡ	ộ	ồ	ổ	ỡ	ọ	ỏ	ơ	ớ	ợ	ờ	ở	ỡ	ú	ù
ocircumflexae	ocircumflex	ocircumflexgr	ocircumflexho	ocircumflextil	odotbelow	ohookabove	ohorn	ohornacute	ohorndotbel	ohorngrave	ohornhooka	ohorntilde	uacute	ugrave
ũ	ụ	ủ	ư	ứ	ự	ừ	ử	ữ	ý	ỳ	ỵ	ỷ	ỹ	
utilde	udotbe	uhookabove	uhorn	uhornacute	uhorndotbel	uhorngrave	uhornhooka	uhorntilde	yacute	ygrave	ydotbelow	yhookabove	ytilde	

## Other

,	;	:	.	...	-	!	¡	?	¿	‘	’	“	”	,
comma	semicolon	colon	period	ellipsis	hyphen	exclam	exclamdown	question	questiondown	quoteleft	quoteright	quotedblleft	quotedblright	quotingsgl
„	<	>	«	»	’	/		—	—	▪	(	)	[	]
quotedblbase	guilsingleft	guilsingright	guillemetlef	guillemetri	apostrophe	slash	bar	endash	emdash	bullet	parenleft	parenright	bracketleft	bracketright
{	}	†	‡	¦	\	_	’	”	&	@	©	®	™	\$
braceleft	braceright	dagger	daggerdbl	brokenbar	backslash	underscore	quotesingle	quotedbl	ampersand	at	copyright	registered	trademark	dollar
¢	£	f	¥	€	₪	₪	₪	₪	₪	₪	₪	₪	₪	₪
cent	sterling	florin	yen	euro	currency	baht	bitcoin	hryvnia	lira	ruble	rupee	tenge	tugrik	won
/	¼	½	¾	⅓	⅔	⅛	⅜	⅝	⅞	%	‰	∅	0	1
fraction	onequarter	onehalf	threequarte	onethird	twothird	oneeighth	threeeighth	fiveeighth	seveeneighth	percent	perthousan	zero.zero	zero	one
2	3	4	5	6	7	8	9	μ	Δ	Ω	π	·	*	+
two	three	four	five	six	seven	eight	nine	mu	Delta	Omega	pi	periodcent	asterisk	plus
-	±	×	÷	=	<	>	°	≈	≥	∞	≤	¬	≠	∫
minus	plusminus	multiply	divide	equal	less	greater	degree	approxsequ	greaterequ	infinity	lessequal	logicalnot	notequal	integral
∂	∏	√	∑	◊	¶	§	^	~	∅	Ω	Δ	μ	#	№
partialdiff	product	radical	summation	lozenge	paragraph	section	asciicircum	asciitilde	emtyset	Ohm	increment	micro	numbersign	numero
♣	↑	↗	→	↘	↓	↙	←	↖	ª	º	ℓ	ℓ		
apple	upArrow	NEArrow	rightArrow	SEArrow	downArrow	SWArrow	leftArrow	NWArrow	ordfeminine	ordmasculine	estimated	literSign		

## Grilli Type

---

GT Pressura

Technical Specifications

---

Latin-alphabet languages:

Abenaki, Afaan, Afar, Afrikaans, Albanian, Alsatian, Amis, Anuta, Aragonese, Aranese, Aromanian, Arrernte, Arvanitic, Asturian, Atayal, Aymara, Azerbaijani, Bashkir, Basque, Belarusian, Bemba, Bikol, Bislama, Bosnian, Breton, Cape Verdean Creole, Catalan, Cebuano, Chamorro, Chavacano, Chichewa, Chickasaw, Cimbrian, Cofán, Cornish, Corsican, Creek, Crimean Tatar, Croatian, Czech, Danish, Dawan, Delaware, Dholuo, Drehu, Dutch, English, Estonian, Faroese, Fijian, Filipino, Finnish, French, Frisian, Friulian, Gagauz, Galician, Ganda, Genoese, German, Gikuyu, Gooniyandi, Greenlandic (Kalaallisut), Guadeloupean Creole, Gwich'in, Haitian Creole, Hän, Hawaiian, Hiligaynon, Hopi, Hotçak, Hungarian, Icelandic, Ido, Igbo, Ilocano, Indonesian, Irish, Istro-Romanian, Italian, Jamaican, Javanese, Jèrriais, Kaingang, Kala Lagaw Ya, Kapampangan, Kaqchikel, Karakalpak, Karelian, Kashubian, Kikongo, Kinyarwanda, Kiribati, Kirundi, Kurdish, Ladin, Latin, Latvian, Lithuanian, Lombard, Low Saxon, Luxembourgish, Maasai, Makhuwa, Malay, Maltese, Manx, Māori, Marquesan, Megleno-Romanian, Meriam Mir, Mirandese, Mohawk, Moldovan, Montagnais, Montenegrin, Murrinh-Patha, Nagamese Creole, Nahuatl, Ndebele, Neapolitan, Ngyambaa, Niuean, Noongar, Norwegian, Occitan, Old Icelandic, Old Norse, Oshiwambo, Ossetian, Palauan, Papiamentu, Piedmontese, Polish, Portuguese, Potawatomi, Q'eqchi', Quechua, Rarotongan, Romanian, Romansh, Rotokas, Inari Sami, Lule Sami, Northern Sami, Southern Sami, Samoan, Sango, Saramaccan, Sardinian, Scottish Gaelic, Serbian, Seri, Seychellois Creole, Shawnee, Shona, Sicilian, Silesian, Slovak, Slovenian, Somali, Upper and Lower Sorbian, Northern and Southern Sotho, Spanish, Sranan, Sundanese, Swahili, Swazi, Swedish, Tagalog, Tahitian, Tetum, Tok Pisin, Tokelauan, Tongan, Tshiluba, Tsonga, Tswana, Tumbuka, Turkish, Turkmen, Tuvaluan, Tzotzil, Uzbek, Venetian, Vepsian, Võro, Wallisian, Walloon, Waray-Waray, Warlpiri, Wayuu, Welsh, Wik-Mungkan, Wiradjuri, Wolof, Xavante, Xhosa, Yapese, Yindjibarndi, Zapotec, Zarma, Zazaki, Zulu, Zuni

Cyrillic-alphabet languages:

Cyrillic-alphabet languages: Abaza, Adyghe, Agul, Avar, Bashkir, Buryat, Chechen, Chuvash, Crimean Tatar, Dargín, Dungan, Ingush, Kabardian, Kalmyk, Karakalpak, Kazakh, Khinalugh, Komi, Kyrgyz, Lak, Lezgian, Moldovan, Mongolian, Ossetian, Rutul, Tabasaran, Tajik, Tat, Tatar, Turkmen, Tuvan, Uyghur, Uzbek, Ukrainian

Further available languages:

Greek, Vietnamese

File Formats

Desktop: OTF  
Web: WOFF2, WOFF, TTF  
App: OTF

Licensing

Free Trial Fonts License

Trial fonts allow you to play with our fonts at no cost. You can use them to create mockups before getting client approval. Students can use them for non-commercial university projects, too.

Desktop License

This license is used for creating printed documents, logos, website graphics, and so on. Desktop fonts are licensed for a certain number of computers in your organization.

Webfont License

This license is what you purchase to use our typefaces on websites with the @font-face technology. You may use them for website mockups. Webfonts are licensed for a certain number of website visitors per month.

App License

This is the license to embed fonts in mobile and desktop applications. App licensing for our fonts is offered for a certain number of developers.

Further licensing types on request.

About GrilliType

Grilli Type is an independent Swiss type foundry. We offer original retail and custom typefaces, high quality products with a contemporary aesthetic in the Swiss tradition. This tradition is reflected in the visual but also the technical standard of our fonts and our service. Together with our designers we create useful, high quality typefaces that stand the test of time.

Contact

mail@grillitype.com  
www.grillitype.com

15pt GT Pressura Light

An intermodal container is a large standardized shipping container, designed and built for intermodal freight transport, meaning these containers

---

20pt GT Pressura Light

Intermodal containers are primarily used to store and transport materials and products efficiently and

---

30pt GT Pressura Light

These containers are known under a number of names, such as simply

---

40pt GT Pressura Light

Intermodal containers exist in many types and a

---

65pt GT Pressura Light

Unloading

---

95pt GT Pressura Light

Fragile

---

120pt GT Pressura Light

Crate

---

160pt GT Pressura Light

TARE

---



130pt GT Pressura Light

LOGISTICS

---

140pt GT Pressura Light

Net Load

---

160pt GT Pressura Light

Re-use

---

15pt GT Pressura Regular

The common heights are 8 feet 6 inches (2.6 m) and 9 feet 6 inches (2.9 m) – the latter are known as High Cube or Hi-Cube containers. Just like

---

20pt GT Pressura Regular

Just like cardboard boxes and pallets, these containers are a means to bundle cargo and goods into larger,

---

30pt GT Pressura Regular

Intermodal containers share a number of key construction features to

---

40pt GT Pressura Regular

Facilitate their handling and to allow stacking, as

---

65pt GT Pressura Regular

Shipment

---

95pt GT Pressura Regular

UIC-590

---

120pt GT Pressura Regular

Steel

---

160 GT Pressura Regular

KKTU

---

130pt GT Pressura Regular

TRANSPORT

---

140pt GT Pressura Regular

Container

---

160pt GT Pressura Regular

Device

---

15pt GT Pressura Bold

**In 2012 there were about 20.5 million intermodal containers in the world of varying types to suit different cargoes. Containers have largely sup-**

---

20pt GT Pressura Bold

**In 2010 containers accounted for 60% of the world's seaborne trade. The predominant alternative meth-**

---

30pt GT Pressura Bold

**The more populous northern part of the country, comprising**

---

40pt GT Pressura Bold

**E.g. by bulk carrier or tank ship, tank car or truck.**

---

65pt GT Pressura Bold

**LOCATION**

---

95pt GT Pressura Bold

**CU.CAP.**

---

120pt GT Pressura Bold

**42G1**

---

160pt GT Pressura Bold

**Unit**

---

130pt GT Pressura Bold

**Storage UP**

---

140pt GT Pressura Bold

**Payload**

---

160pt GT Pressura Bold

**MAX. WT.**

---

15pt GT Pressura Light

Кавказская пленница, или новые приключения Шурика с английскими субтитрами — кинофильм Леонида Гайдая, снятый в 1966 году. Вто-

20pt GT Pressura Light

Не смотря на то, что с момента выхода фильма «Кавказская пленница» прошло почти полвека его об-

30pt GT Pressura Light

В ходе изучения местных тостов и обычаев ему предлагают лично

40pt GT Pressura Light

А он своими собственными руками передаст ее в

65pt GT Pressura Light

английском

95pt GT Pressura Light

фильмы

120pt GT Pressura Light

Языке

160pt GT Pressura Light

МОЙ

130pt GT Pressura Light

Поступления

---

140pt GT Pressura Light

Знакомые

---

160pt GT Pressura Light

ДЕТСТВА

---

15pt GT Pressura Regular

Иди и смотри с английскими субтитрами — советский фильм режиссёра Элема Климова, снятый в жанре военной драмы по сценарию Алеся

---

20pt GT Pressura Regular

Вышедший в прокат в 1985 году, к сорокалетию Победы в Великой Отечественной войне, фильм был

---

30pt GT Pressura Regular

его просмотрели 29,8 млн зрителей. По опросу читателей журнала

---

40pt GT Pressura Regular

был признан лучшим фильмом 1986 года, а

65pt GT Pressura Regular

Храни меня

---

95pt GT Pressura Regular

Вернусь

---

120pt GT Pressura Regular

РУКА

---

160 GT Pressura Regular

ИЛИ



130pt GT Pressura Regular

Васильевич

---

140pt GT Pressura Regular

СЛЕЗАМ

---

160pt GT Pressura Regular

Ночной

---

15pt GT Pressura Bold

**Флера — шестнадцатилетний мальчишка, откопавший среди обрывков колючей проволоки, ржавых пулеметных лент и простреленных**

---

20pt GT Pressura Bold

**В конце, пройдя через ужас карательной акции фашистов, становится взрослым, пугающе взрос-**

---

30pt GT Pressura Bold

**Война исказила когда-то нежные, детские черты и превратила их**

---

40pt GT Pressura Bold

**Джентельмены  
удачи на ан-  
глийском языке**

---

65pt GT Pressura Bold

**Шурика**

---

95pt GT Pressura Bold

**Смотри**

---

120pt GT Pressura Bold

**Удачи**

---

160pt GT Pressura Bold

**Мир**

---

130pt GT Pressura Bold

Советские

---

140pt GT Pressura Bold

Хорошем

---

160pt GT Pressura Bold

ОНЛАЙН

---

15pt GT Pressura Mono Light

By the 1830s, railways on several continents were carrying containers that could be transferred to other

---

20pt GT Pressura Mono Light

The Liverpool and Manchester Railway in the United Kingdom was one of these.

---

30pt GT Pressura Mono Light

Simple rectangular timber boxes, four to a truck, they

---

40pt GT Pressura Mono Light

Early versions of standardized contain-

---

65pt GT Pressura Mono Light

Material

---

95pt GT Pressura Mono Light

Cargo

---

120pt GT Pressura Mono Light

Load

---

160pt GT Pressura Mono Light

CAIU

---

130pt GT Pressura Mono Light

PRODUCTES

---

140pt GT Pressura Mono Light

Harbor

---

160pt GT Pressura Mono Light

Caution

---

15pt GT Pressura Mono Regular

Construction of these containers had a steel frame with wooden walls, floor, roof and doors. The first in-

---

20pt GT Pressura Mono Regular

in 1933, and a second one in 1935, primarily for transport between European

---

30pt GT Pressura Mono Regular

In November 1932, the first container terminal in the

---

40pt GT Pressura Mono Regular

Resulting economic collapse and drop in

---

65pt GT Pressura Mono Regular

Ubiquity

---

95pt GT Pressura Mono Regular

Reload

---

120pt GT Pressura Mono Regular

Dock

---

160 GT Pressura Mono Regular

Food

---

130pt GT Pressura Mono Regular

CAPACITY

---

140pt GT Pressura Mono Regular

Trailer

---

160pt GT Pressura Mono Regular

Ocean

---

15pt GT Pressura Mono Bold

In April 1951 at Zürich Tiefenbrunnen railway station the Swiss Museum of Transport and the Bureau Interna-

---

20pt GT Pressura Mono Bold

A system was selected for Western Europe, based on the Netherlands' system

---

30pt GT Pressura Mono Bold

This system used roller containers for transport by

---

40pt GT Pressura Mono Bold

Capacity, and up to 3.1 by 2.3 by 2 me-

---

65pt GT Pressura Mono Bold

Freight

---

95pt GT Pressura Mono Bold

Train

---

120pt GT Pressura Mono Bold

Crane

---

160pt GT Pressura Mono Bold

Size

---



130pt GT Pressura Mono Bold

**Chemicals**

---

140pt GT Pressura Mono Bold

**LBS 1G32**

---

160pt GT Pressura Mono Bold

**1 Tonne**

---

15pt GT Pressura Mono Light

советская комедия, снятая в 1971  
году режиссёром Александром Серым.  
Лидер советского кинопроката в 1972

---

20pt GT Pressura Mono Light

свыше 65 миллионов зрите-  
лей. Это один из самых  
популярных советских кино-

---

30pt GT Pressura Mono Light

Заведующий детским  
садом Трошкин ока-  
зался совершенной

---

40pt GT Pressura Mono Light

Трошкина в  
группу бывших  
поделельников

---

65pt GT Pressura Mono Light

Хорошем

---

95pt GT Pressura Mono Light

Онлайн

---

120pt GT Pressura Mono Light

HD720

---

160pt GT Pressura Mono Light

ТУН

---

130pt GT Pressura Mono Light

КИН - ДЗА - ДЗА

---

140pt GT Pressura Mono Light

СИНДРОМ

---

160pt GT Pressura Mono Light

ПОМОГУТ

---

15pt GT Pressura Mono Regular

Не являясь москвичами, при всём желании они не могут назвать места, где побывал Доцент и где они в по-

---

20pt GT Pressura Mono Regular

Надо ехать в Москву и «показывать пальцем». Сотрудники милиции готовят «по-

---

30pt GT Pressura Mono Regular

Далее Трошкин должен привезти их в Москву, чтобы там

---

40pt GT Pressura Mono Regular

Вместе с напарниками Доцента убегает

---

65pt GT Pressura Mono Regular

Солярис

---

95pt GT Pressura Mono Regular

УДАЧИ

---

120pt GT Pressura Mono Regular

Дозор

---

160 GT Pressura Mono Regular

СВОИ

---

130pt GT Pressura Mono Regular

Кавказская

---

140pt GT Pressura Mono Regular

СТАЛКЕР

---

160pt GT Pressura Mono Regular

Меняет

---

15pt GT Pressura Mono Bold

**разводивший бензин ослиной мочой –  
Василий Алибабаевич (Али-Баба). Его  
приходится взять с собой. Смотреть**

---

20pt GT Pressura Mono Bold

**Служебный роман с англий-  
скими субтитрами is a  
Soviet comedy film directed**

---

30pt GT Pressura Mono Bold

**Кин-дза-дза! на ан-  
глийском языке или  
с английскими суб-**

---

40pt GT Pressura Mono Bold

**но-фантасти-  
ческий фильм  
в жанре ан-**

---

65pt GT Pressura Mono Bold

**Ночной**

---

95pt GT Pressura Mono Bold

**Брат 2**

---

120pt GT Pressura Mono Bold

**Берн**

---

160pt GT Pressura Mono Bold

**Веве**

---

130pt GT Pressura Mono Bold

Винтертур

---

140pt GT Pressura Mono Bold

Золотурн

---

160pt GT Pressura Mono Bold

ЛУГ АНО

---

15pt GT Pressura Light

Με τον ελληνικό όρο εμπορευματοκιβώτιο αποδίδεται ο διεθνής όρος κοντέινερ (container) που αφορά ειδική, κυρίως μεταλλική, κατασκευή,

20pt GT Pressura Light

Πρόκειται, δηλαδή, για μεγάλα μεταλλικά (σιδερένια ή αλουμινένια) κιβώτια με τα οποία σήμερα έχει γενικευ-

30pt GT Pressura Light

Το εμπορευματοκιβώτιο εξασφαλίζει αφενός ασφαλεία φορτίου, αφετέρου

40pt GT Pressura Light

Τα πλοία που μεταφέρουν έτοιμα συσκευασμένα φορ-

65pt GT Pressura Light

Εκφόρτωση

95pt GT Pressura Light

Απόβαρο

120pt GT Pressura Light

Υλικό

160pt GT Pressura Light

ΝΕΡΟ



130pt GT Pressura Light

ΕΥΘΡΑΥΣΤΟ

---

140pt GT Pressura Light

Σακαράκα

---

160pt GT Pressura Light

Μονάδα

---

15pt GT Pressura Regular

Σήμερα η μεταφορά φορτίων σε τέτοιες κατασκευές είναι πλέον ευρύτερα διαδεδομένη. Αυτό οδήγησε από νωρίς σε διεθνή πρακτική τα εμπορευματο-

20pt GT Pressura Regular

Αυτό οδήγησε από νωρίς σε διεθνή πρακτική τα εμπορευματοκιβώτια να διακρίνονται σε σταθερές (διεθνείς)

30pt GT Pressura Regular

Έτσι τυποποιήθηκαν τρεις κατηγορίες κοντέινερς:  
Κατηγορία

40pt GT Pressura Regular

Κατηγορία Ι. Στη κατηγορία αυτή περιλαμβάνονται

65pt GT Pressura Regular

Παραγωγή

95pt GT Pressura Regular

Φορτίο

120pt GT Pressura Regular

Πλοίο

160 GT Pressura Regular

Σάλτ

130pt GT Pressura Regular

ΤΡΟΧΟΣΠΙΤΟ

---

140pt GT Pressura Regular

Μέγεθος

---

160pt GT Pressura Regular

Φορτώνω

---

15pt GT Pressura Bold

Για τις φορτοεκφορτώσεις των κοντέινερς απαραίτητες τυγχάνουν οι ανάλογες (ειδικές) λιμενικές εγκαταστάσεις και διευκολύνσεις. Οι εγκαταστά-

20pt GT Pressura Bold

Πρόκειται για προβλήτες ακριβώς έναντι μεγάλων σε έκταση συνήθως υποκείμενων χώρων με ειδικούς

30pt GT Pressura Bold

Προς εφαρμογή αυτού του τρόπου μεταφορών των φορτίων και την

40pt GT Pressura Bold

χρησιμοποιείται ευρύτερα και ευχερέστερα ο διε-

65pt GT Pressura Bold

ΠΡΟΣΟΧΗ

95pt GT Pressura Bold

Ωκεανός

120pt GT Pressura Bold

ΤΡΕΝΟ

160pt GT Pressura Bold

Κιλό

130pt GT Pressura Bold

Τοποθεσία

---

140pt GT Pressura Bold

Αποστολή

---

160pt GT Pressura Bold

ΣΥΣΚΕΥΗ

---

15pt GT Pressura Mono Light

Ένας από τους πλέον μοντέρνους τύ-  
πους φορτηγών πλοίων είναι το λεγό-  
μενο κοντέινερσιπ ή απλά κοντέινερ

20pt GT Pressura Mono Light

Επίσημη ονομασία στην ελ-  
ληνική είναι εμπορευματο-  
κιβωτιοφόρο αλλά λόγω της

30pt GT Pressura Mono Light

Τα πλοία αυτού του  
τύπου έχουν ναυπη-  
γηθεί έτσι ώστε

40pt GT Pressura Mono Light

Φέρουν δε ει-  
δικές υποδοχές  
σύμφωνα με δι-

65pt GT Pressura Mono Light

Μεταφορά

95pt GT Pressura Mono Light

Ατσάλι

120pt GT Pressura Mono Light

Τροφή

160pt GT Pressura Mono Light

ΜΑΖΑ

130pt GT Pressura Mono Light

ΓΡΑΜΜΑΡΙΟ

---

140pt GT Pressura Mono Light

Γερμανός

---

160pt GT Pressura Mono Light

Δοχείο

---

15pt GT Pressura Mono Regular

Τα πλοία αυτά, με το είδος αυτό μεταφοράς των φορτίων περιορίζουν χρονικά στο ελάχιστο τη παραμονή τους

20pt GT Pressura Mono Regular

Στη ναυτιλιακή οικονομία πράγματι ο τρόπος αυτός διακίνησης συσκευασμένων

30pt GT Pressura Mono Regular

Ακόμη και τ' ασφάλιστρα των "κοντεϊνεράιζιγκ" φορτί-

40pt GT Pressura Mono Regular

Συνέπεια δε αυτών υπήρξε νέα επίσης πο-

65pt GT Pressura Mono Regular

Προκυμαία

95pt GT Pressura Mono Regular

Λιμάνι

120pt GT Pressura Mono Regular

668ης

160 GT Pressura Mono Regular

ΣΤΟΚ



130pt GT Pressura Mono Regular

ΜΕΤΑΦΟΡΑ

---

140pt GT Pressura Mono Regular

Καθαρό

---

160pt GT Pressura Mono Regular

Φορτίο

---

15pt GT Pressura Mono Bold

σημείων φορτοεκφόρτωσης των, και με ενίσχυση μέσω και ειδικών γερανών σε μοντέρνες πλέον τεχνικές υποδομές

20pt GT Pressura Mono Bold

Βέβαια πολλά κοντέινερς πλοία διαθέτουν επίσης δικά τους μέσα φορτοεκφόρ-

30pt GT Pressura Mono Bold

Η μεγαλύτερη στην Ελλάδα τέτοια προβλήτα υποδοχής

40pt GT Pressura Mono Bold

προς το Πέραμα, την οικονομική εκμε-

65pt GT Pressura Mono Bold

Πρότυπο

95pt GT Pressura Mono Bold

Χάλυβα

120pt GT Pressura Mono Bold

Βαθμό

160pt GT Pressura Mono Bold

ΣΤΟΚ

130pt GT Pressura Mono Bold

Ναυτιλιακό

---

140pt GT Pressura Mono Bold

Ορίζεται

---

160pt GT Pressura Mono Bold

ΔΙΕΘΝΗ

---